



# BEYOND THE EDGE WITH THE HILTI METHOD FOR FASTENING DESIGN

Improved design for anchors under  
shear loading

Version 1.1  
October 2024



## TABLE OF CONTENTS

<b>1. Introduction and background .....</b>	<b>2</b>
<b>2. Anchor configurations and the design provisions covered by EN 1992-4 .....</b>	<b>3</b>
2.1 Anchor layouts and static shear load distribution	3
2.2 Anchor layouts and seismic load distribution	5
<b>3. State-of-art approach for shear load distribution in FIB Billetin 58.....</b>	<b>5</b>
<b>4. SOFA – expansion of layouts and shear distribution .....</b>	<b>6</b>
4.1 Anchor layouts and shear distribution for static and seismic loading	6
4.2 Bandwidth Approach for misaligned anchors	8
4.3 Larger layouts and impacts on concrete breakout	8
4.4 Shear distribution parallel and perpendicular to the edge	9
<b>5. Resistance verification in SOFA method for static and seismic shear loading.....</b>	<b>11</b>
5.1 Resistance verification in SOFA method for static and seismic shear loading	11
5.2 Verification against concrete edge break-out failure	12
5.3 Verification against combined loading	14
<b>6. Design examples using PROFIS Engineering .....</b>	<b>14</b>
6.1 Design of anchor layout 3x3 using EN 1992-4 and SOFA (fib Bulletin 58)	14
6.2 Design of anchor layout 5x3 using SOFA	17
<b>7. Available options in PROFIS Engineering .....</b>	<b>19</b>
<b>8. Conclusion.....</b>	<b>20</b>
<b>9. References .....</b>	<b>21</b>



## 1. INTRODUCTION AND BACKGROUND

Fasteners play a key role in ensuring the performance and durability of structures, with their use in the construction industry evolving significantly over the past two decades. It is now common practice to attach structural and non-structural elements to existing reinforced concrete (RC) members by using post-installed connections. Depending on design requirements for the structure and especially the fastening, the anchor configuration can vary to a point where the regular arrangements specified in national and international fastening design guidelines do not suffice. For instance, critical structural connections positioned close to the edge and loaded in shear may need more flexibility in anchorage design that often exceeds the current scope of the available design standards. The design of connections further requires flexibility when sustaining load combinations for static and seismic, and often due to the geometrical limitations. For the complex and unique projects, fastening design may require exceeding the limits set forth by design standards such as EN 1992-4 [1], whilst maintaining the same reliability of the fasteners and the overall connection.

This article presents an expansion to the design provisions contained in the current EN 1992-4 [1] under the “Hilti **SOFA Method**” (**Solutions for Fastening**) which allows shear distribution to more rows beyond the front one for concrete edge break-out verification. This expansion focuses on the design of anchors beyond the standard approach in EN 1992-4 [1] and provides more flexibility in consideration of the number of anchors in a group when loaded in shear close to one or more concrete edges. The paper outlines the current scope of design in EN 1992-4 [1] and limitations (Chapter 2), the state-of-the-art approach for shear load distribution according to *fib* Bulletin 58 [2] (Chapter 3), expansion of the anchor layout and shear load distribution as per SOFA (Chapter 4), verification of resistances against tension and shear loading (Chapter 5), and worked design examples using PROFIS Engineering (Chapter 6 and 7).



Fig. 1.1: Critical anchor arrangements at jobsite

## 2. ANCHOR CONFIGURATIONS AND THE DESIGN PROVISIONS COVERED BY EN 1992-4

EN 1992-4 [1] provides provisions for the design of fastenings for use in concrete. These provisions reflect the foundational empirical experience that account for various uncertainties to ensure a high level of safety, but ones that may not always lead to the most optimized design. One consequence of the foundational empirical evidence is the applicability of the design provisions of EN 1992-4 [1] is the limitation of the anchor group configurations, shown in Fig. 2.1 and Fig. 2.2. An anchor located at an edge distance  $\geq \max(10h_{ef}; 60d_{nom})$  is deemed as “*far from the edge*”, otherwise it is considered as “*near to the edge*”. In “*far from edge*” conditions, the check for concrete edge break-out under shear loading may be omitted. Fig. 2.1 shows permitted anchor configurations for anchor groups without hole clearance for all edge distances and load directions, and fastenings with normal hole clearance according to EN 1992-4 [1], Table 6.1 situated far from edges for all load directions and situated near to edge loaded in tension only. Fig. 2.2 shows covered anchor configurations for groups with a hole clearance situated near to edge for all load directions.

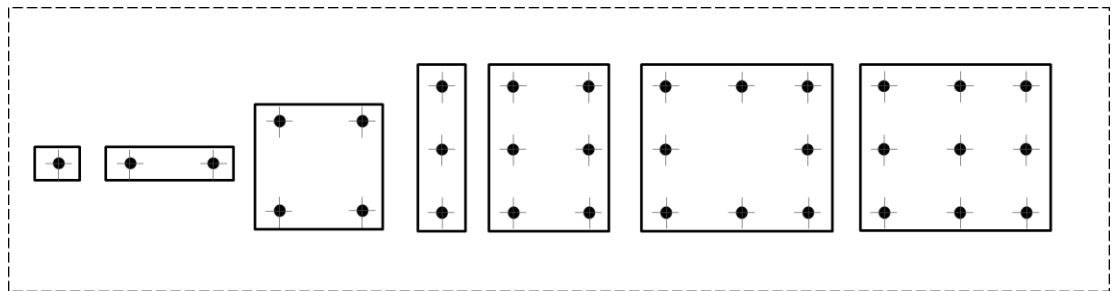

Fig. 2.1: Anchor groups without hole clearance for all edge distances covered by EN 1992-4

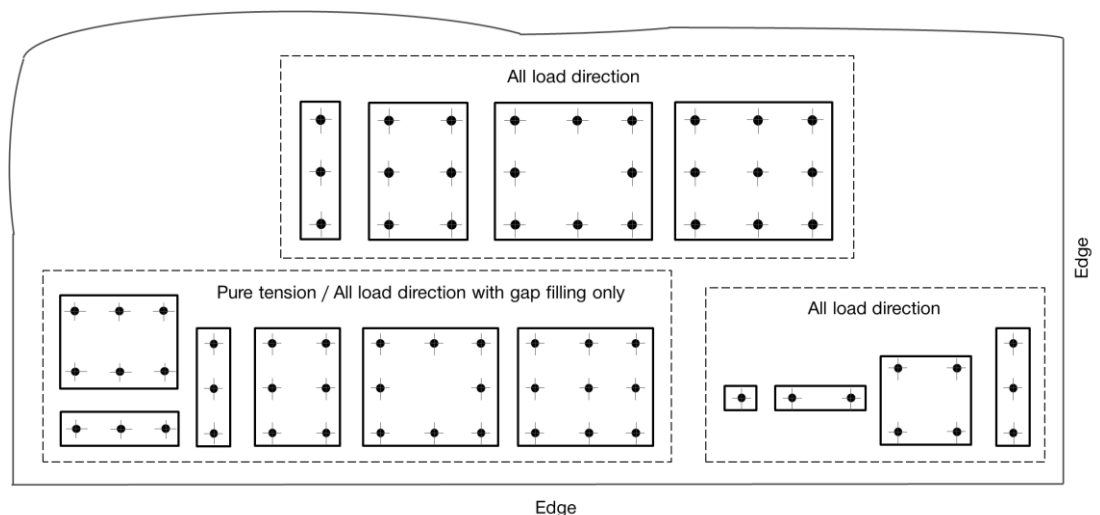

Fig. 2.2: Anchor groups with / without hole clearances situated near to edge covered by EN 1992-4

### 2.1 Anchor layouts and static shear load distribution

EN 1992-4 [1] allows engineers to design anchor layout options up to 3x3. The term “hole clearance” refers to the annular gap between the anchor and the fixture (or baseplate).

Shear applied on the baseplate is distributed to the anchors based on its effectiveness to resist shear load, which in turn is dependent on the hole clearance and the edge distance. If the hole is slotted in the direction of the shear force, then the anchor does not resist the shear loads. All anchors are considered to resist shear load if it acts parallel to the edge, the anchors are subject to torsion, or the anchors are located far from the edge ( $c_i \geq \max\{10h_{ef}; 60d_{nom}\}$ ). For steel and pry-out checks, all anchors of an anchor group are considered effective. For concrete edge failure check, only the anchors close to the edge ( $c_i < \max\{10h_{ef}; 60d_{nom}\}$ ) are assumed to resist the shear that acts perpendicular or parallel to the edge.

Table 2.1 shows the static shear load distribution through the anchors close to edge conditions according to EN 1992-4 [1].

Table 2.1: Shear load distribution for anchors close to edge,  $c_i \leq \max(10h_{ef}; 60d_{nom})$  according to EN 1992-4

Anchor layout	With hole clearance	Without hole clearance
	Front row of anchors	Front row of anchors
	Not in the scope	Front row of anchors

Fig. 2.3 and Fig. 2.4 describe how shear acts on the anchors and how anchors participate in sharing the shear load. In the case of a group of anchors loaded parallel to the edge, the shear is divided **equally amongst all anchors**, with verification for edge breakout required only for the anchors nearest to edge. For a group of anchors loaded perpendicular to the edge, the shear load is divided equally between the row of anchors nearest to the edge, with any components of shear acting away from the edge are neglected when verifying resistance to concrete edge breakout, i.e., shear must be resisted entirely by the front row.

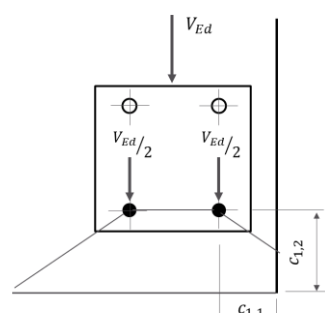

Fig. 2.3: Group of four anchors close to an edge loaded perpendicular to the edge

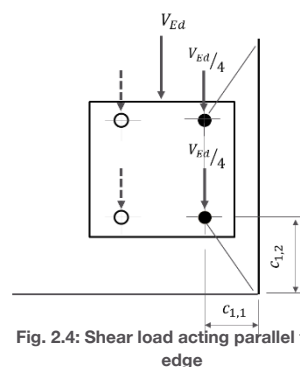

Fig. 2.4: Shear load acting parallel to the edge

Legend:

- Loaded anchor
- Unloaded anchor
- ↓ Shear load distribution considered for edge failure
- ⋮ ↓ Load distribution neglected for anchor

EN 1992-4 [1] allows anchors in base plates extending beyond the concrete with hole clearance as shown in Fig. 2.5.

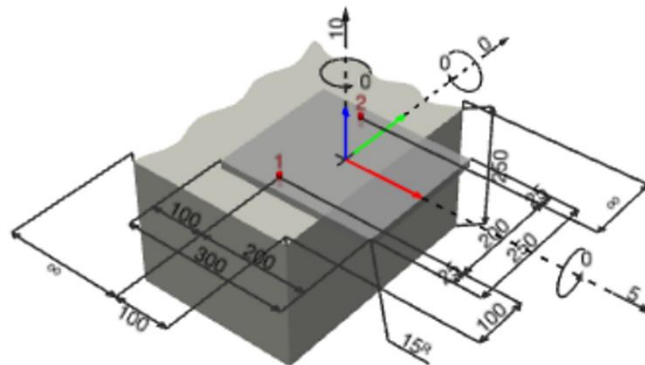

Fig. 2.5: Anchors with hole clearance in a baseplate extending beyond the concrete edge

## 2.2 Anchor layouts and seismic load distribution

The anchor layout and seismic shear load distribution in EN 1992-4 [1] follow the same provisions as stated in the Section 2.1. Since the concrete edge breakout checks are ignored when anchors loaded in shear are far from the edge or when shear is directed away from the edge, all layouts in Table 2.1 are permitted.

In summary, EN 1992-4 [1] includes the scope of design of anchors up to 3x3 and shear distribution to the front row of anchors. The *fib* Bulletin 58 [2] “*Design of anchorages in concrete*” contains additional design provisions for resistance against shear load.

## 3. STATE-OF-ART APPROACH FOR SHEAR LOAD DISTRIBUTION IN FIB BILLETIN 58

As covered in Section 2.1 of this document, EN 1992-4 [1], Section 6.2.2.2 specifies just one approach to determine which anchors in a group participate in resisting shear acting towards an edge, with no or normal hole clearance determining which anchor group configuration can or cannot be positioned near an edge. The *fib* Bulletin 58 [2], Section 4.3.1.3 includes another, less restrictive approach to determine which anchors in a group participate in resisting shear, which is independent of: (1) the hole clearance between the baseplate and anchors; and (2) the anchor group configurations.

In both EN 1992-4 [1] and *fib* Bulletin 58 [2], when an anchor group situated near an edge is loaded in shear perpendicular to that edge, all anchors participate in resisting shear failure in steel and concrete pry-out, with the provisions in the former only allowing anchors closest to the edge (front row) effectively resist shear failure in concrete edge breakout. The *fib* Bulletin 58 [2] does not restrict edge breakout solely to anchors in the front row and allows anchors in the second and / or third rows parallel to the edge to also participate in resisting concrete edge breakout. Here, the governing failure plane is not *always* the front row, and concrete edge breakout must be verified for all failure planes, as illustrated by Fig. 3.1.

Distinction is made, however, in relation to hole clearance: under normal hole clearance, the assumed failure plane for edge breakout should remain at the front row of anchors to avoid an unacceptable loss in serviceability.

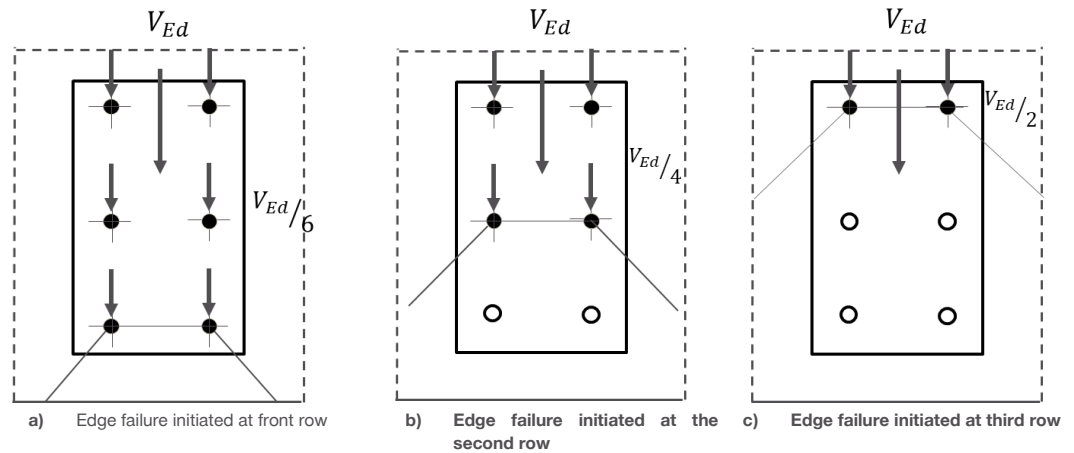

Fig. 3.1: Perpendicular shear load distribution and edge failure in the scope of fib Bulletin 58

The shear load distribution parallel to the edge from front row to back row of anchors towards concrete edge break-out failure cracks is shown in Fig. 3.2.

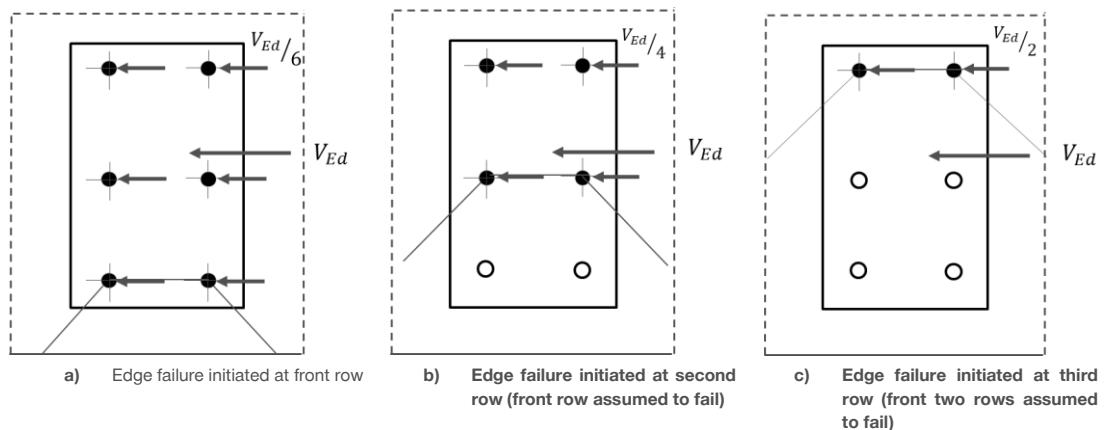

Fig. 3.2: Parallel shear load distribution and edge failure in the scope of fib Bulletin 58

While the *fib* Bulletin 58 [2] allows distribution of shear beyond the front rows for edge breakout, the anchor groups are still restricted to 3x3 grid without hole clearance and to 2x2 with hole clearance, see Figure 4.3-1 of [2]. Anchor layouts beyond 3x3 and irregular configuration, such as triangular and circular, are not covered in either EN 1992-4 [1] or *fib* Bulletin 58 [2].

## 4. SOFA – EXPANSION OF LAYOUTS AND SHEAR DISTRIBUTION

### 4.1 Anchor layouts and shear distribution for static and seismic loading

The SOFA method includes the *fib* Bulletin 58 [2] provisions for shear distribution to all participating anchors within three rows in a group parallel to the edge and expands the layouts to which it applies. This enables the designer to model fastening layouts loaded in shear towards the edge that exceed those in both EN 1992-4 [1] and the *fib* Bulletin 58 [2], with the prerequisite that no hole clearance exists between both anchor and baseplate. For the different anchor arrangements, the static and seismic shear distribution for anchors close to edge allowed in SOFA are explained in Table 4.1.

For both static and seismic loading, shear distribution for regular layouts of anchors (within and beyond 3x3) follows the same approach as defined in Table 4.1. However, limits are placed based on current knowledge and irregular layouts and large anchor groups ( $n_i \times n_j > 16$ ) must resist shear entirely by the front row of anchor(s). For seismic shear loading, the bandwidth approach does not apply. In this document,  $n_j$  refers to the number of rows perpendicular to the edge and  $n_i$  refers to the number of anchors per row.

Table 4.1: Shear load distribution for anchors close to edge,  $c_i \leq \max(10h_{ef}; 60d_{nom})$  for static and seismic conditions

Anchor layout		With hole clearance	Without hole clearance
Rectangular up to 2x2		Front row of anchors	Back row of anchors
Rectangular up to 3x3		Not in the scope	Back row of anchors
Rectangular beyond 3x3 with $n_i \leq 5$ , $n_j \leq 5$ , and $n_i \times n_j \leq 16$		Not in the scope	Limited to third row of anchors
Rectangular beyond 3x3 but $n_i \leq 5$ , $n_j \leq 5$ , and $n_i \times n_j > 16$		Not in the scope	Front row of anchors ( <b>static only</b> )
Triangular		Not in the scope	Front row of anchors with bandwidth approach ( <b>static only</b> )
Circular		Not in the scope	Front row of anchors with bandwidth approach ( <b>static only</b> )
Other anchor layouts up to 99 anchors		Not in the scope	Front row of anchors with bandwidth approach ( <b>static only</b> )

The layouts as mentioned in Table 4.1 are also applicable for anchors located far from edge, however shear distribution becomes irrelevant.



## 4.2 Bandwidth Approach for misaligned anchors

For orthogonal layouts in design, all anchors may perfectly align in a row, but onsite execution may not always be as “millimetre” precise, leading to an overestimation of resistance if the failure plane were to initiate from the anchor nearest to the edge. However, the failure plane for concrete edge breakout does not require perfect alignment of all anchors in a row and the failure plane may encompass other anchors as they activate within a defined virtual “band”. As shown in **Error! Reference source not found.**, the band includes any anchors within a quarter of the maximum spacing in the  $y$ -direction ( $s_{y,max}$ ) – identical for the  $x$ -direction ( $s_{x,max}$ ) if an adjacent edge exists – thus extending the breakout body using the smallest edge distance and thereby increasing the concrete edge resistance.

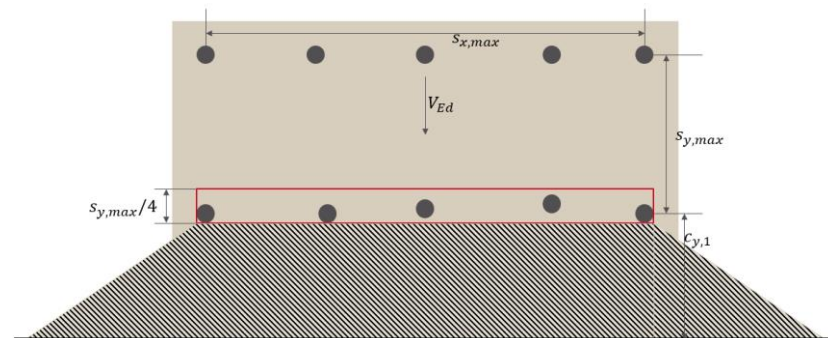

Fig. 4.1: Definition of the band demarcated by the red box shown for one edge

## 4.3 Larger layouts and impacts on concrete breakout

As noted in Table 4.1, while shear transfer beyond the front row of anchors is possible up to three rows parallel to edge, Figure 4.3-1 of the *fib* Bulletin 58 [2] explicitly limits the anchor groups to a rectangular 3x3 layout, limiting, by extension, the number of anchors per row to three. Such restrictive layouts may be insufficient for fastening primary structural steel elements that typically resist high shear forces. By removing limitations on the layouts, the SOFA method enables the designer to model any layout, regular or irregular. However, expanding the possible layouts **without** considering the participation of the back rows in resisting concrete edge breakout would lead to illogical scenarios where, for instance, only the row nearest to the edge in a 4x2 layout would resist shear, meaning a 3x2 layout would provide higher resistance as it could engage all three rows parallel to the edge. The SOFA method avoids this by allowing the first three rows of a 4x2 anchor layout to participate in resisting edge breakout in shear.

Furthermore, the SOFA method also incorporates the work of Grosser [3], which demonstrated that a larger number of anchors (five) per row can participate in resisting shear, thereby enlarging the concrete breakout body,  $A_{c,V}$ , and consequently generating a higher resistance. Again, this also **requires no hole clearance** between the anchor and the baseplate’s holes as all anchors must be loaded simultaneously to avoid a “shear lag” effect that may arise if the spacing becomes unduly large. Combined, these extensions are valid only for layouts up to 16 anchors as further experimental investigations are still required to validate the model for much larger groups.

An example of concrete edge break-out for a 5x3 anchor layout is shown in Fig. 4.2, where a shear force,  $V_{Ed}$ , acts perpendicular to an edge, thereby activating the middle row (the concrete breakout bodies for the front and rear rows are not shown as a simplification).

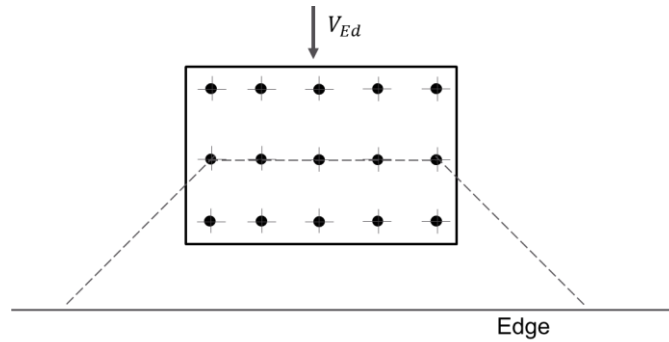

Fig. 4.2: Edge break-out for anchors 5x3 layout close to edge and loaded in shear for static and seismic

If the anchors in the same group with two adjacent edges were now loaded with inclined shear, edge breakout must be verified for each edge, as shown in Fig. 4.3.

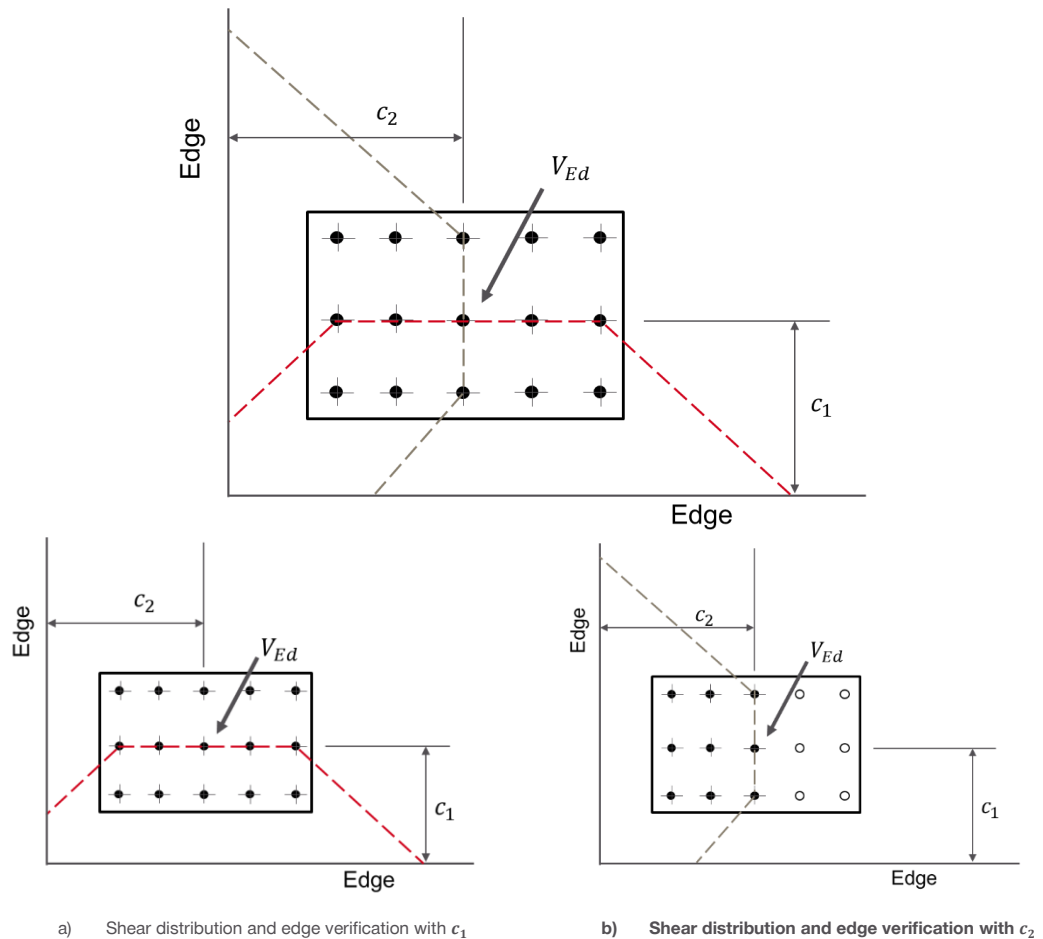

Fig. 4.3: Anchors loaded in inclined shear

#### 4.4 Shear distribution parallel and perpendicular to the edge

Before verifying each edge, knowing the shear that acts on each row,  $V_{Ed, row, i}$ , is paramount. Here, Table 4.3-2 of [2] provides guidance. For instance, shear perpendicular to an edge is distributed as  $V_{Ed, row 1} = 0.5V_{Ed}$  for first row,  $V_{Ed, row 2} = V_{Ed}$  for second row of anchors for necessary edge failure verification. For

a maximum of three rows, the load would then be split as  $V_{Ed,row1} = 0.33V_{Ed}$  for first row,  $V_{Ed,row2} = 0.67V_{Ed}$  for second row of anchors, and finally  $V_{Ed,row3} = V_{Ed}$  for the third row.

The above does not apply shear acting parallel to an edge, as the failure load is typically twice the failure load perpendicular to the same edge and only the anchor row nearest to the edge is verified as per EN 1992-4 [1]. The SOFA method distributes the load equally between the anchor rows as  $V_{Ed,row1} = V_{Ed,row2} = V_{Ed,row3} = 0.33V_{Ed}$ . When the fastening is subject to biaxial shear, the shear distribution for anchors up to three rows parallel to the edge is calculated using following equations:

$$V_{Ed,row1} = \sqrt{\left(\sum V_{Ed,perp,row1}\right)^2 + \left(\sum V_{Ed,parallel,row1}\right)^2}$$

$$V_{Ed,row2} = \sqrt{\left(\sum V_{Ed,perp,row2} + V_{Ed,perp,row1}\right)^2 + \left(\sum V_{Ed,parallel,row2}\right)^2}$$

$$V_{Ed,row3} = \sqrt{\left(\sum V_{Ed,perp,row3} + V_{Ed,perp,row2} + V_{Ed,perp,row1}\right)^2 + \left(\sum V_{Ed,parallel,row3}\right)^2}$$

If the fastening has more than three rows of anchors parallel to the edge under consideration, then it is necessary to recalculate and transfer all the load perpendicular to the edge to the first three rows of anchors.

Consistent with the provisions in EN 1992-4 [1] and the *fib* Bulletin 58 [2], shear acts with an eccentricity,  $e_V$ , remains the same when verifying all rows. The angle,  $\alpha_V$ , is calculated for the actual load acting on each row (see Fig. 4.4).

**Note:** In case of anchors more than 5 numbers in a row, only 5 anchors will contribute to the shear force

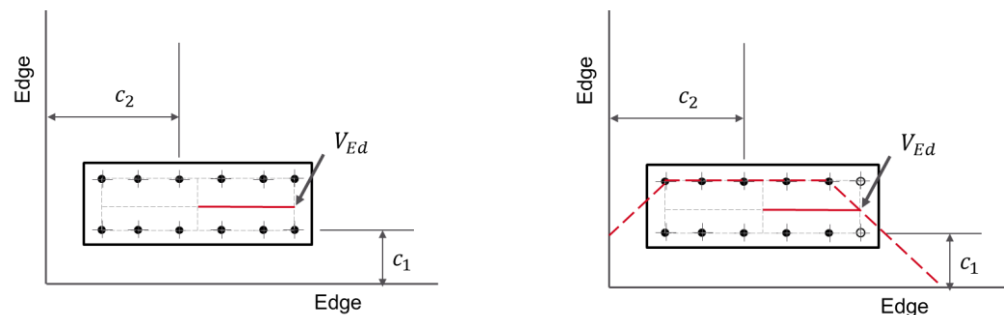

Fig. 4.4: Shear load with inclination and eccentricity, with the corresponding concrete break-out bodies

#### Shear load acting perpendicular to edge:

The participation of anchors in shear load acting perpendicular to edge is presented in Fig. 4.5.

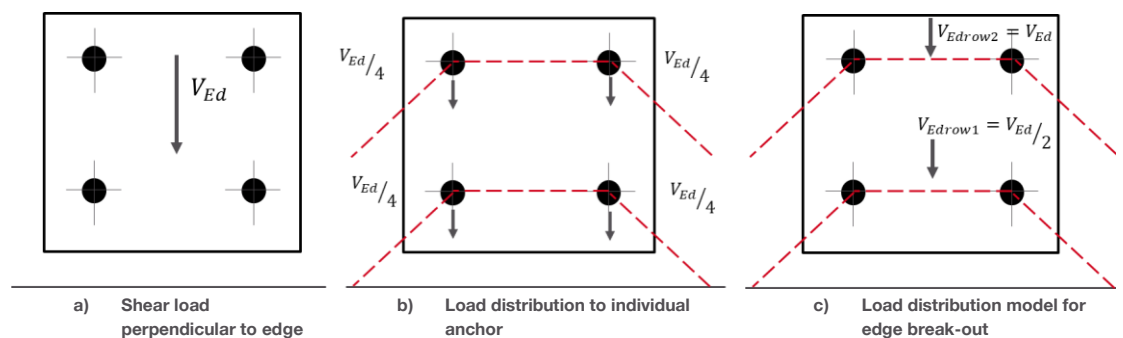

Fig. 4.5: Perpendicular shear distribution and edge break-out model as per SOFA

#### Shear load acting parallel to edge:

The participation of anchors in shear load acting parallel to edge is presented in Fig. 4.6.

**Note:** Shear force acting parallel to edge-checking of front row only for edge break-out is sufficient.

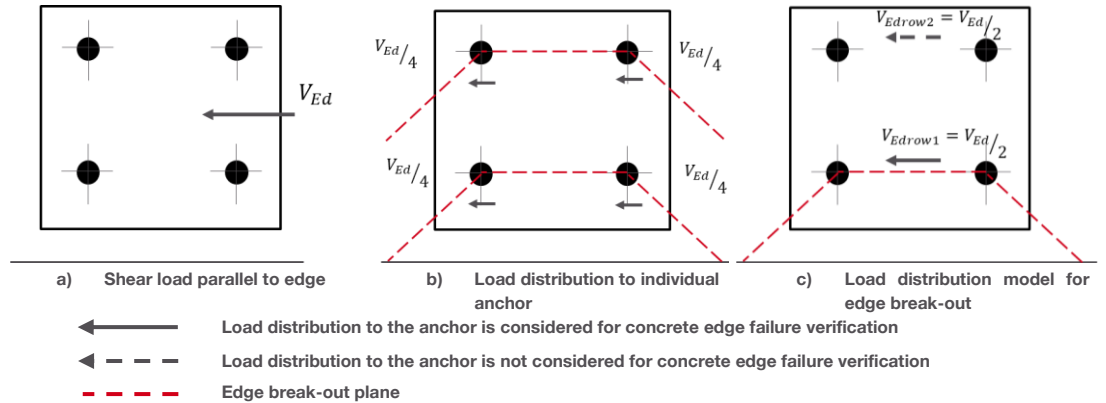

Fig. 4.6: Parallel shear distribution and edge break-out model as per SOFA

#### Torsion acting on group of anchors:

With torsional loading acting on anchor group the moment is resolved in components and shear force component which act towards the edge is considered in final load distribution model (Fig. 4.7)

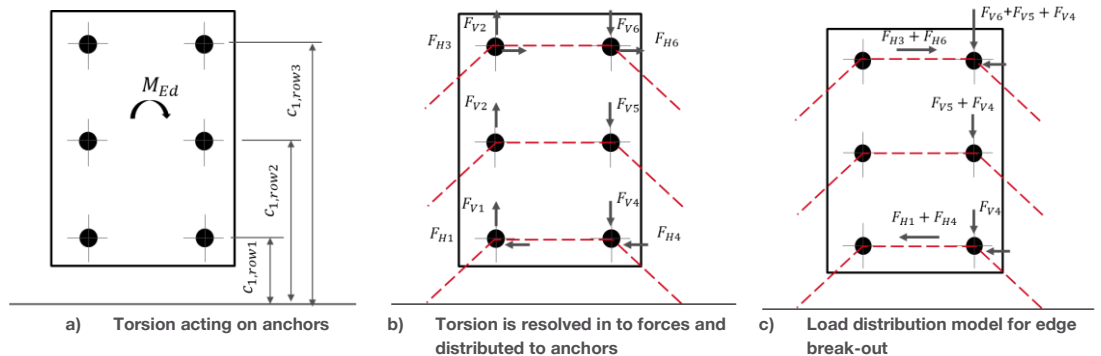

Fig. 4.7: Torsion distribution and edge break-out model as per SOFA

## 5. RESISTANCE VERIFICATION IN SOFA METHOD FOR STATIC AND SEISMIC SHEAR LOADING

### 5.1 Resistance verification in SOFA method for static and seismic shear loading

#### Resistance verification for anchor layout regular up to 3x3

The resistance against static and seismic shear for anchor layout regular up to 3x3 follows the design criteria as mentioned in [1] (refer to

Table 5.1). The resistance verifications to both tension and combined tension and shear loading are not mentioned in this section as they follow the requirements of [1] without modifications.

Table 5.1: Resistance verification for anchor layout up to 3x3

Loading	Failure mode	Static	Seismic
---------	--------------	--------	---------

<b>Shear</b>	Steel without lever arm	EN 1992-4, section 7.2.2.3.1	+Annex C, C.5
	Steel with lever arm	EN 1992-4, section 7.2.2.3.2	+Annex C, C.5
	Pry-out	EN 1992-4, section 7.2.2.4	+Annex C, C.5
	Concrete edge breakout	Where shear load transfer to the back row is not possible: EN1992-4, section 7.2.2.5. Where shear load transfer to the back rows is possible: fib Bulletin 58	+Annex C, C.5

### Resistance verification for anchor layout regular beyond 3x3

The design resistance against tension and shear loading for anchor layout beyond 3x3 are calculated using design provisions in [1] with additional scope defined in SOFA method (refer to Table 5.2).

Table 5.2: Resistance verification for anchor layout beyond 3x3

Loading	Failure mode	Static	Seismic
<b>Shear</b>	Steel without lever arm	EN1992-4, section 7.2.2.3.1	EN 1992-4, Annex C, Section C.5
	Steel with lever arm	EN1992-4, section 7.2.2.3.2	Not in the scope
	Pry-out	EN1992-4, section 7.2.2.4 where $N_{Rk,c}$ is determined as per SOFA	EN 1992-4, Annex C, Section C.5 where $N_{Rk,c}$ is determined per SOFA
	Concrete edge breakout	Where shear load is transferred to the front row and SOFA bandwidth: EN1992-4, section 7.2.2.5.	EN 1992-4, Annex C, Section C.5

**Note:** The reduction factor  $\alpha_{eq}$  for SOFA method also follows the scope and Table C.3 mentioned in [1]. Factor for gap filling  $\alpha_{gap}$  is considered as 0.5 without the Hilti Filling Set and 1.0 with the Filling Set. The SOFA method requires no hole clearance to function, hence  $\alpha_{gap} = 1.0$ .

Verification against tension loading including all influencing factors (area of concrete engaged, group effect, presence of supplementary reinforcement, proximity of edge, eccentricity, bending moment etc.) follow the design criteria included in the scope of [1].

## 5.2 Verification against concrete edge break-out failure

The characteristic resistance for steel failure without lever arm  $V_{Rk,s}$  is taken directly from the product relevant ETA, with the resistance verified for the load on each anchor.

Concrete pry-out failure is verified according to the equations mentioned in [1].

### Concrete edge break-out resistance with hole clearance:

The edge resistance for anchors with hole clearance is verified using the design criteria defined in [1], however the modified edge distance,  $c'_1$ , and reference and projected areas  $A_{c,v}$  and  $A_{c,v}^0$  are calculated using the distance approach for regular and irregular layouts.

### Concrete edge break-out resistance verification for anchors without hole clearance



The verification is performed per row according to the formula below and with the loads used to determine the eccentricity and the angle applied on the verified row.

$$V_{Rk,c,row,i} = V_{Rk,c}^0 \cdot \frac{A_{c,V}}{A_{c,V}^0} \cdot \psi_{h,V} \cdot \psi_{s,V} \cdot \psi_{ec,V} \cdot \psi_{\alpha,V} \cdot \psi_{re,V} \quad \text{Eq. (7.40) [1]}$$

The characteristic resistance for single anchor without any other influence is calculated by following equation:

$$V_{Rk,c}^0 = k_v \cdot d_{nom}^\alpha \cdot l_f^\beta \cdot \sqrt{f_{ck}} \cdot c^{1.5} \quad \text{Eq. (7.41) [1]}$$

**Note:** For spacing greater than critical,  $s_{cr}$  to be used as  $\leq 3c_1$

Area ratio, i.e. the ratio between actual projected area and idealised cone area is calculated according to [1].

The factor  $k_v$  is 1.7 for cracked concrete and 2.4 for uncracked concrete. The powers  $\alpha$  and  $\beta$  depend on edge distance ( $c_1$ ), depth ( $l_f$ ), and diameter of anchors ( $d_{nom}$ ).  $f_{ck}$  is the grade of concrete.

$$\alpha = 0.1 \cdot \left(\frac{l_f}{c_1}\right)^{0.5} \quad \text{Eq. (7.42) [1]}$$

$$\beta = 0.1 \cdot \left(\frac{d_{nom}}{c_1}\right)^{0.2} \quad \text{Eq. (7.43) [1]}$$

The edge influence is accounted by a factor  $\psi_{s,V}$  and calculated by following equation:

$$\psi_{s,V} = 0.7 + 0.3 \cdot \left(\frac{c_2}{1.5c_1}\right) \leq 1.0 \quad \text{Eq. (7.45) [1]}$$

The factor which takes care of disproportional change of edge resistance with respect to change in concrete thickness is defined as,  $\psi_{h,V} = \sqrt{\left(\frac{1.5c_1}{h}\right)} \geq 1.0$  Eq. (7.46) [1]

The eccentricity factor  $\psi_{ec,V} = \frac{1}{\left(1 + \frac{2e_V}{3c_1}\right)} \leq 1.0$  considers the group effect for eccentricity of loading.

The reinforcement factor  $\psi_{re,V}$  is considered as 1.0 without supplementary reinforcement and 1.4 for additional reinforcements applicable for the provisions as defined in eqs. (10.2-5g<sub>1</sub> and 10.2-5g<sub>2</sub>) in [2].

The angle factor (considers the angle between shear load and a line perpendicular to the verified edge) for SOFA method follows the equation mentioned below:

$$\psi_{\alpha,V} = \frac{1}{\sqrt{(\cos \alpha_V)^2 + \left(\frac{\sin \alpha_V}{\psi_{90^\circ,V}}\right)^2}} \quad \text{Eq. (10.2-5f) [2]}$$

$$\psi_{90^\circ,V} = 4.0 \cdot k_4 \cdot \left(\frac{n_2 \cdot d_{nom}^2 \cdot f_{ck}}{V_{Rk,c,\perp}}\right) \leq 4.0 \quad \text{Eq. (10.2-5f<sub>1</sub>) [2]}$$

$V_{Rk,c,\perp}$  = concrete breakout resistance for loading perpendicular to an edge according to Eq. (10.2-5) [2] without the factor  $\psi_{\alpha,V}$ .

$k_4$  = 1.0 for anchorages without hole clearances; 0.8 for anchors with normal hole clearance. The 0.8 factor does not apply since normal hole clearance is not permitted shear loads acting on fastenings close to the edge.

$n_2$  = number of anchors for which concrete edge is verified, restricted to  $n_2 \leq 5$  due to limited experience.

### 5.3 Verification against combined loading

The design verification is done separately for steel failure and for failures other than steel by the equations mentioned in Table 5.3.

Table 5.3: Verification against combined action

Failure mode	Verification
<b>Steel</b>	$\left(\frac{N_{Ed}}{N_{Rd,s}}\right)^2 + \left(\frac{V_{Ed}}{V_{Rd,s}}\right)^2 \leq 1$
<b>Failure mode other than steel</b>	$\left(\frac{N_{Ed}}{N_{Rd,i}}\right)^2 + \left(\frac{V_{Ed}}{V_{Rd,i}}\right)^2 \leq 1$ or $\frac{N_{Ed}}{N_{Rd,i}} + \frac{V_{Ed}}{V_{Rd,i}} \leq 1.2$ and $\frac{N_{Ed}}{N_{Rd,i}} \leq 1$ and $\frac{V_{Ed}}{V_{Rd,i}} \leq 1$ , largest value $\frac{N_{Ed}}{N_{Rd,i}}$ and $\frac{V_{Ed}}{V_{Rd,i}}$ for different failure modes must be considered

**Note:** Shear load with lever arm (stand-off) is not in the scope for verification. For more details, please see Hilti whitepapers [4] and [5]

## 6. DESIGN EXAMPLES USING PROFIS ENGINEERING

### 6.1 Design of anchor layout 3x3 using EN 1992-4 and SOFA (fib Bulletin 58)

Project requirement: An angle (L section) is connected to concrete wall using post-installed mechanical anchors. The 3D view of the applications is shown in Fig. 6.1 and other information on this project is defined in Table 6.1.

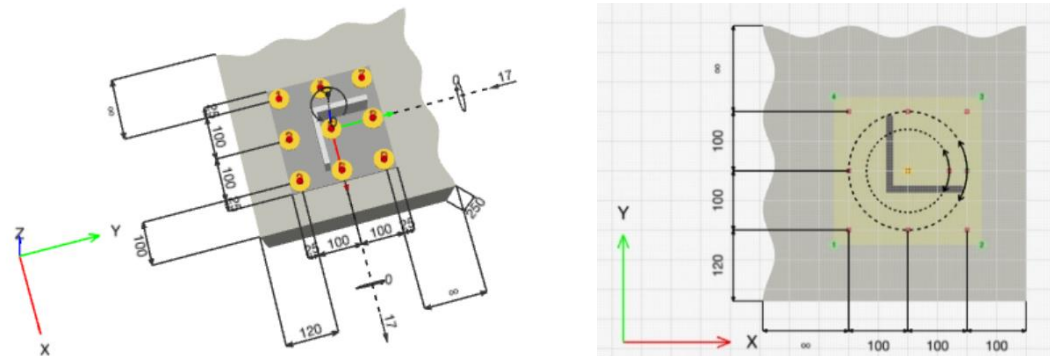

Fig. 6.1: Baseplate connection using post-installed anchors (3x3)

Table 6.1: Project information and design inputs

Geometry	
Concrete thickness	250 mm
Baseplate	250x250x10 mm
Steel profile	L 130x12 mm
Spacing between anchors (X and Y)	100 mm
Edge distance (X and Y)	100 mm and 120 mm
Others	
Materials	Concrete C20/25
Design life	50 years
Installation	Rotary-hammer drilling / horizontal, dry

ANCHOR LOADS			
Anchor	N [kN]	Vx [kN]	Vy [kN]
1	0	1.889	-1.889
2	0	1.889	-1.889
3	0	1.889	-1.889
4	0	1.889	-1.889

The total shear force per anchor is  $V_{sd} = 2.67 \text{ kN}$  and for anchor group,  $V_{Ed} = 24 \text{ kN}$

Details of proposed anchor: The proposed anchor solution (without hole clearance) is defined in Table 6.2.

Table 6.2: Anchor properties

Type of anchor	Mechanical	
Specification of anchor	HST4-R	
Diameter of anchor	$d$	16 mm
Effective embedment depth	$h_{ef}$	96 mm
Nominal embedment depth	$h_{nom}$	108 mm



Design verifications are carried considering rigid baseplate as per [1] and characteristic resistances are taken from ETA-21/0878 [6]

#### Steel failure:

The resistance against steel failure is calculated for the most stressed anchor using following equation:

$$V_{Rd,s} = \frac{V_{Rk,s}}{\gamma_{Ms}} \quad \text{Table 7.2 [1]}$$

$$\gamma_{Ms} = 1.25 \quad \text{Table C2 [6]}$$

$$V_{Rk,s} = 72.4 \text{ kN} \quad \text{Table C2 [6]}$$

$$V_{Rd,s} = \left( \frac{72.4}{1.25} \right) = 57.9 \text{ kN} > V_{Sd} = 2.67 \text{ kN} \quad \text{verification fulfilled } \checkmark$$

#### Concrete pry-out failure:

The resistance against concrete pry-out failure is calculated for the group of anchors:

$$V_{Rk,cp} = k_8 \cdot N_{Rk,c} \quad \text{Eq. (7.39a) [1]}$$

$$V_{Rd,cp} = \frac{V_{Rk,cp}}{\gamma_{Mcp}} \quad \text{Table 7.2 [1]}$$

$$\gamma_{Mcp} = 1.5 \quad \text{Table C2 [6]}$$

$$k_8 = 2.74 \quad \text{Table C2 [6]}$$

The characteristic resistance of a single anchor is taken from the check of concrete cone failure:

$$N_{Rk,c}^0 = k_1 \cdot \sqrt{f_{ck}} \cdot h_{ef}^{1.5} = 8.9 \cdot \sqrt{20} \cdot 96^{1.5} = 37.4 \text{ kN}, \quad \text{Table C1 [6] and Eq. (7.2) [1]}$$

$$s_{cr,N} = 2 \cdot c_{cr,N} = 3 \cdot h_{ef} = (3 \cdot 96) = 288 \text{ mm}, c_{cr,N} = 144 \text{ mm} \quad \text{Sect. 7.2.1.4 (3) [1]}$$

$$\psi_{s,N} = 0.7 + 0.3 \cdot \frac{c}{c_{cr,N}} = 0.7 + 0.3 \cdot \left( \frac{100}{144} \right) = 0.91 \quad \text{Eq. (7.4) [1]}$$

$$\psi_{re,N} = 1.0, \psi_{ec,N} = 1.0$$

$$A_{c,N} = (100 + 200 + 144) \cdot (120 + 200 + 144) = 206,016 \text{ mm}^2 \quad \text{Fig. 7.4 [1]}$$

$$A_{c,N}^0 = s_{cr,N} \cdot s_{cr,N} = (288 \cdot 288) = 82,944 \text{ mm}^2 \quad \text{Eq. (7.3) [1]}$$

$$N_{Rk,c} = N_{Rk,c}^0 \cdot \frac{A_{c,N}}{A_{c,N}^0} \cdot \psi_{s,N} \cdot \psi_{re,N} \cdot \psi_{ec,N} = 37.4 \cdot \frac{206,016}{82,944} \cdot 0.91 \cdot 1.0 \cdot 1.0 = 84.5 \text{ kN}$$

$$V_{Rk,cp} = 84.5 \cdot 3.0 = 253.4 \text{ kN}$$

$$V_{Rd,cp} = \left( \frac{253.4}{1.5} \right) = 168.9 \text{ kN} > V_{Ed} = 24 \text{ kN} \quad \text{verification fulfilled } \checkmark$$

#### Concrete edge failure: shear acting perpendicular to edge in $Y^-$ direction (decisive edge)

The edge break-out resistance has been calculated for both the edges,  $Y^-$  and  $X^+$ . It has been observed that the resistance is lesser and the critical edge break-out is in the direction of  $Y^-$ . Hence the calculation has been shown here for the decisive edge,  $Y^-$ .

$$V_{Rd,c} = \frac{V_{Rk,c}}{\gamma_{Mc}} \quad \text{Table 7.2 [1]}$$

$$\gamma_{Mc} = 1.5 \quad \text{Table C2 [6]}$$

$$l_f = h_{ef} = 96 \text{ mm}, c_1 = 120 \text{ mm}, c_2 = 100 \text{ mm}, k_v = 1.7 \text{ for cracked concrete}$$

$$\alpha = 0.1 \cdot \left(\frac{l_f}{c_1}\right)^{0.5} = 0.1 \cdot \left(\frac{96}{120}\right)^{0.5} = 0.089 \quad \text{Eq. (7.42) [1]}$$

$$\beta = 0.1 \cdot \left(\frac{d_{nom}}{c_1}\right)^{0.2} = 0.1 \cdot \left(\frac{16}{120}\right)^{0.2} = 0.067 \quad \text{Eq. (7.43) [1]}$$

$$V_{Rk,c}^0 = k_v \cdot d_{nom}^\alpha \cdot l_f^\beta \cdot \sqrt{f_{ck}} \cdot c_1^{1.5} = 1.7 \cdot 16^{0.089} \cdot 96^{0.067} \cdot \sqrt{20} \cdot 120^{1.5} = 17.4 \text{ kN} \quad \text{Eq. (7.41) [1]}$$

$$A_{c,v}^0 = 4.5 c_1^2 = 4.5 \cdot 120^2 = 64,800 \text{ mm}^2 \quad \text{Eq. (7.44) [1]}$$

$$A_{c,v} = (100 + 200 + 1.5 \cdot 120) \cdot (1.5 \cdot 120) = 86,400 \text{ mm}^2$$

$$\psi_{s,v} = 0.7 + 0.3 \cdot \left(\frac{c_2}{1.5c_1}\right) \leq 1.0 = 0.7 + 0.3 \cdot \left(\frac{100}{1.5 \cdot 120}\right) = 0.87$$

$$\psi_{h,v} = 1.0, \psi_{ec,v} = 1.0, \psi_{\alpha,v} = 1.04 \text{ for } \alpha_v = 18.43^\circ$$

$$V_{Rk,c} = 17.4 \cdot \frac{86,400}{64,800} \cdot 1.04 \cdot 1.0 \cdot 0.87 \cdot 1.0 \cdot 1.0 = 20.9 \text{ kN}$$

$$V_{Rd,c} = \left(\frac{20.9}{1.5}\right) = 13.9 \text{ kN} < V_{Ed} = 24 \text{ kN} \quad \text{verification not fulfilled ❌}$$

Now design verifications are carried out considering rigid baseplate as per [2] i.e., SOFA method where the concrete edge break-out resistance is higher than the value as per [1].

Concrete edge failure as per SOFA method considering back rows for shear:

The force is distributed in the back anchors as per [2] and hence edge distance is higher,  $c_1 = 320 \text{ mm}$ .

$$V_{Rd,c} = \frac{V_{Rk,c}}{\gamma_{Mc}} \quad \text{Table 7.2 [1]}$$

$$\gamma_{Mc} = 1.5 \quad \text{Table C2 [6]}$$

$$l_f = h_{ef} = 96 \text{ mm}, c_2 = 100 \text{ mm}, k_v = 1.7 \text{ for cracked concrete}$$

$$\alpha = 0.1 \cdot \left(\frac{l_f}{c_1}\right)^{0.5} = 0.1 \cdot \left(\frac{96}{320}\right)^{0.5} = 0.055 \quad \text{Eq. (7.42) [1]}$$

$$\beta = 0.1 \cdot \left(\frac{d_{nom}}{c_1}\right)^{0.2} = 0.1 \cdot \left(\frac{16}{320}\right)^{0.2} = 0.055 \quad \text{Eq. (7.43) [1]}$$

$$V_{Rk,c}^0 = k_v \cdot d_{nom}^\alpha \cdot l_f^\beta \cdot \sqrt{f_{ck}} \cdot c_1^{1.5} = 1.7 \cdot 16^{0.055} \cdot 96^{0.055} \cdot \sqrt{20} \cdot 320^{1.5} = 65.1 \text{ kN} \quad \text{Eq. (7.41) [1]}$$

$$A_{c,v}^0 = 4.5 c_1^2 = 4.5 \cdot 320^2 = 460,800 \text{ mm}^2 \quad \text{Eq. (7.44) [1]}$$

$$A_{c,v} = (100 + 200 + 1.5 \cdot 320) \cdot (250) = 195,000 \text{ mm}^2$$

$$\psi_{s,v} = 0.7 + 0.3 \cdot \left(\frac{c_2}{1.5c_1}\right) \leq 1.0 = 0.7 + 0.3 \cdot \left(\frac{100}{1.5 \cdot 320}\right) = 0.76$$

$$\psi_{h,v} = \left(\frac{1.5 \cdot 320}{250}\right)^{0.5} = 1.386, \psi_{ec,v} = 1.0, \psi_{\alpha,v} = 1.313 \text{ for } \alpha_v = 45^\circ, \psi_{90^\circ,v} = 2.5$$

$$V_{Rk,c} = 65.1 \cdot \frac{195,000}{460,800} \cdot 1.313 \cdot 1.386 \cdot 0.76 \cdot 1.0 \cdot 1.0 = 38.2 \text{ kN}$$

$$V_{Rd,c} = \left(\frac{38.2}{1.5}\right) = 25.5 \text{ kN} \geq V_{Ed} = 24 \text{ kN} \quad \text{verification fulfilled ✅}$$

**Note:** It is observed that using SOFA method with shear distribution considerations in [2], the max utilization has improved from **129%** to **95%**. Hence the design is satisfied.

## 6.2 Design of anchor layout 5x3 using SOFA

Project requirement: A steel column is connected to a concrete element using post-installed chemical anchors. The arrangement of anchors is of 5x3 rectangular layout, and the 3D view of the application is shown in Fig. 6.2 and other information on this project is defined in Table 6.3.

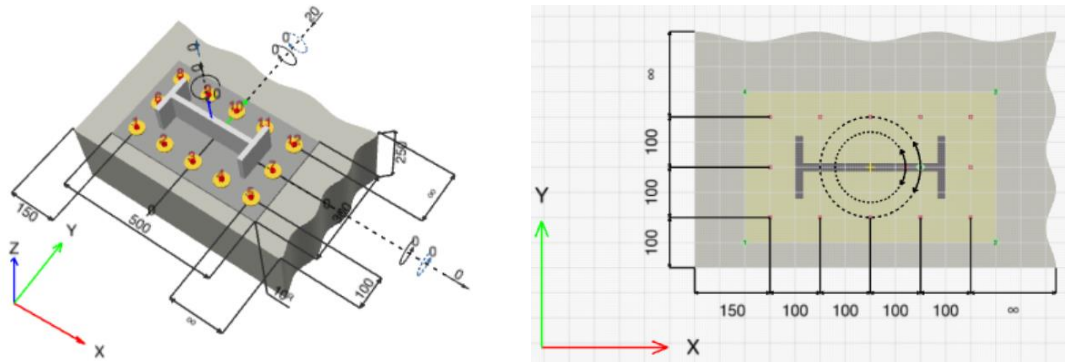

Fig. 6.2: Baseplate connection using post-installed anchors (5x3)

Table 6.3: Project information and design inputs

Geometry		Anchor	N [kN]	Vx [kN]	Vy [kN]
Concrete thickness	250 mm	1	0	0	-1.667
Baseplate	500x300x10 mm	2	0	0	-1.667
I profile	I section I 300	3	0	0	-1.667
Spacing between anchors (X and Y)	100 mm	4	0	0	-1.667
Edge distance (X and Y)	100 mm and 150 mm				
Others					
Materials	Concrete C20/25,				
Design life	50 years				
Installation	Rotary-hammer drilling / horizontal, dry				

Details of proposed anchor: The proposed anchor solution (without hole clearance) is defined in Table 6.4.

Table 6.4: Anchor properties

Type of anchor	Mechanical	
Specification of anchor	HIT-HY 200 +HAS-U 8.8	
Diameter of anchor	$d$	12 mm
Effective embedment depth	$h_{ef}$	70 mm



The design of anchor layout 5x3 is not in the scope of [1] and hence design verifications are carried considering rigid baseplate as per SOFA method and characteristic resistances are taken from ETA-19/0601 [7]

Steel failure:

The resistance against steel failure is calculated for the most stressed anchor using following equation:

$$V_{Rd,s,eq} = \frac{V_{Rk,s,eq}}{\gamma_{Ms}}$$

Table 7.2 [1]



$$\gamma_{Ms} = 1.25 \quad \text{Table C2 [7]}$$

$$V_{Rk,s}^0 = 28 \text{ kN} \quad \text{Table C24 [7]}$$

$$V_{Rk,s} = k_7 \cdot V_{Rk,s}^0 = 28 \text{ kN}$$

$$\alpha_{gap} = 1.0, \alpha_{eq} = 0.85 \quad \text{Eq. (7.35) and C.8 [1]}$$

$$V_{Rk,s,eq} = \alpha_{gap} \cdot \alpha_{eq} \cdot V_{Rk,s} = 23.8 \text{ kN}$$

$$V_{Rd,s,eq} = \left( \frac{23.8}{1.25} \right) = 19 \text{ kN} > V_{Ed} = 1.67 \text{ kN} \quad \text{verification fulfilled } \checkmark$$

Concrete pry-out failure:

The resistance against concrete pry-out failure is calculated for the group of anchors:

$$V_{Rd,cp,eq} = \frac{V_{Rk,cp,eq}}{\gamma_{Mcp}} \quad \text{Table 7.2 [1]}$$

$$\gamma_{Mcp} = 1.5$$

$$k_8 = 2 \quad \text{Table C2 [7]}$$

The characteristic resistance of a single anchor is taken from the check of concrete cone failure:

$$N_{Rk,c}^0 = 20.2 \text{ kN}, \psi_{s,N} = 0.986, \psi_{re,N} = 1.0, \psi_{ec,N} = 1.0$$

$$A_{c,N} = (105 + 200 + 100) \cdot (105 + 400 + 105) = 247,050 \text{ mm}^2 \quad \text{Fig. 7.4 [1]}$$

$$A_{c,N}^0 = s_{cr,N} \cdot s_{cr,N} = (210 \cdot 210) = 44,100 \text{ mm}^2 \quad \text{Eq. (7.3) [1]}$$

$$N_{Rk,c} = 20.2 \cdot \frac{247,050}{44,100} \cdot 0.986 \cdot 1.0 \cdot 1.0 = 111.4 \text{ kN}$$

$$V_{Rk,cp} = 111.4 \cdot 2 = 222.8 \text{ kN}$$

$$\alpha_{gap} = 1.0, \alpha_{eq} = 0.75 \quad \text{Eq. (7.35) and C.8 [1]}$$

$$V_{Rk,cp,eq} = \alpha_{gap} \cdot \alpha_{eq} \cdot V_{Rk,cp} = 167.1 \text{ kN}$$

$$V_{Rd,cp,eq} = \left( \frac{167.1}{1.5} \right) = 111.4 \text{ kN} > V_{Ed} = 20 \text{ kN} \quad \text{verification fulfilled } \checkmark$$

Concrete edge failure: Shear acting perpendicular to edge X<sup>+</sup> (decisive edge)

The edge X<sup>+</sup> is decisive as the edge distance of front row is smaller than the other one and shear is acting perpendicular to this edge. Also, the critical edge failure plane is at third row of anchors, hence the edge distance is 300 mm. Accordingly, the resistance against concrete edge is checked for the shear force perpendicular to bottom edge in the direction of X<sup>+</sup>(Fig. 6.3).

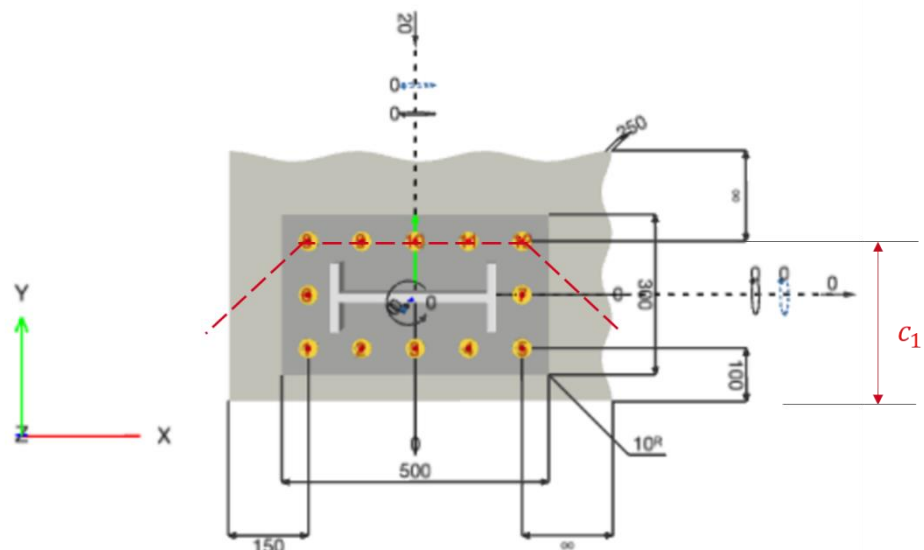

Fig. 6.3: Edge distance consideration for shear perpendicular to edge as per SOFA method

$$V_{Rd,c} = \frac{V_{Rk,c}}{\gamma_{Mc}} \quad \text{Table 7.2 [1]}$$

$$\gamma_{Mc} = 1.5$$

$$l_f = h_{ef} = 70 \text{ mm}, c_1 = 300 \text{ mm}, k_v = 1.7 \text{ for cracked concrete}$$

$$\alpha = 0.1 \cdot \left(\frac{70}{300}\right)^{0.5} = 0.048 \quad \text{Eq. (7.42) [1]}$$

$$\beta = 0.1 \cdot \left(\frac{12}{300}\right)^{0.2} = 0.053 \quad \text{Eq. (7.43) [1]}$$

$$V_{Rkc}^0 = 1.7 \cdot 12^{0.048} \cdot 70^{0.053} \cdot \sqrt{20} \cdot 300^{1.5} = 55.7 \text{ kN} \quad \text{Eq. (7.41) [1]}$$

$$A_{c,v}^0 = 250,000 \text{ mm}^2, A_{c,v} = 405,000 \text{ mm}^2 \quad \text{Eq. (7.44) [1]}$$

$$\psi_{s,v} = 0.8, \psi_{h,v} = 1.342, \psi_{ec,v} = 1.0, \psi_{\alpha,v} = 1.0$$

$$V_{Rk,c} = 55.7 \cdot \frac{405,000}{250,000} \cdot 0.8 \cdot 1.342 \cdot 1.0 \cdot 1.0 \cdot 1.0 = 36.9 \text{ kN}$$

$$\alpha_{gap} = 1.0, \alpha_{eq} = 0.85 \quad \text{Eq. (7.35) and C.8 [1]}$$

$$V_{Rk,cp,eq} = \alpha_{gap} \cdot \alpha_{eq} \cdot V_{Rk,cp} = 31.4 \text{ kN}$$

$$V_{Rd,c} = \left(\frac{31.4}{1.5}\right) = 20.9 \text{ kN} > V_{Ed} = 20 \text{ kN} \quad \text{verification fulfilled } \checkmark$$

## 7. AVAILABLE OPTIONS IN PROFIS ENGINEERING

PROFIS Engineering is user-friendly, cloud-based structural engineering design software that includes modules for various construction applications for steel-to-concrete connection. The software provides options for designing anchors according to EN 1992-4 [1] and the SOFA method. Predefined anchor layouts with different anchor configurations are available and the layout can be customised using the option as shown in Fig. 7.1.

Design methods can be selected from the dropdown menu for EN 1992-4 [1], ETAG and SOFA method. For anchor layouts beyond 3x3 the software provides a warning message with an option to change the method to SOFA with gap filling (Fig. 7.2). Tension, shear load, and moment can be assigned as design load inputs, with inclined shear load can be added after resolving it in parallel and perpendicular components. PROFIS allows the design both for static and seismic loading.

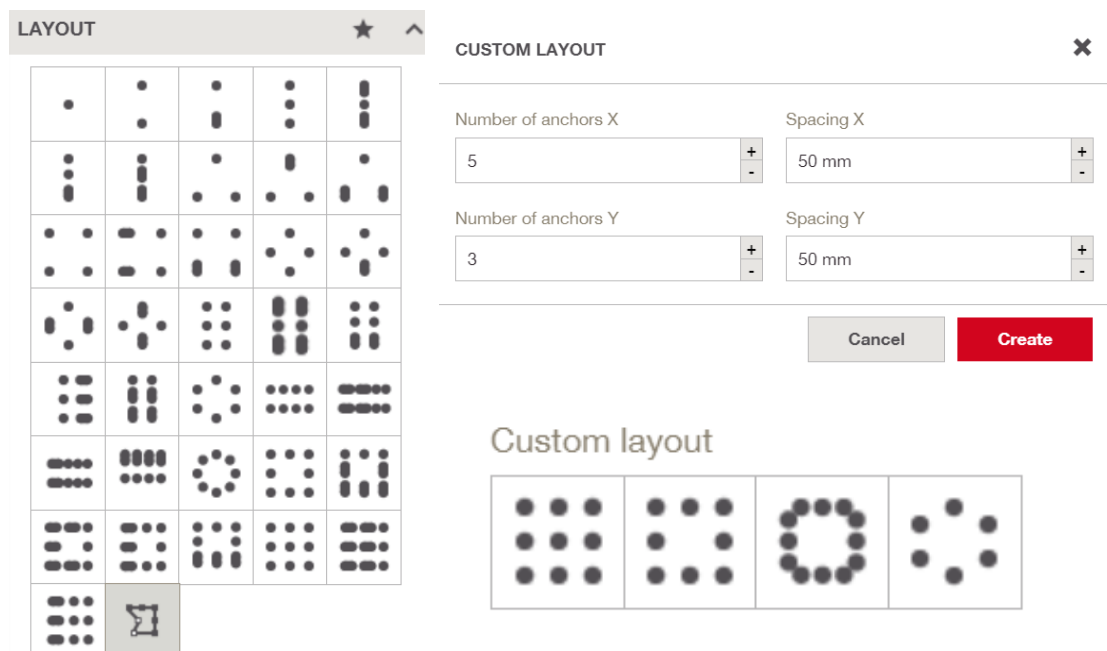

Fig. 7.1: Available options for anchor layout in PROFIS

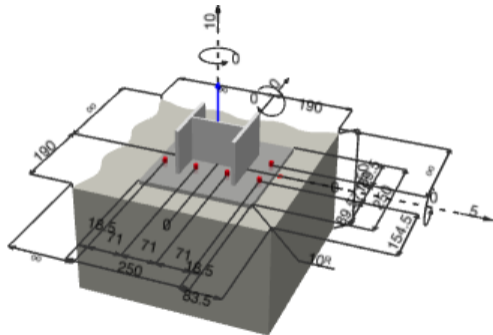
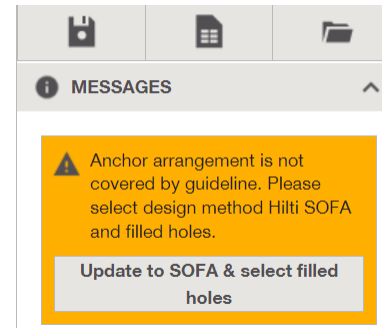

Fig. 7.2: Selection of design method in PROFIS



## 8. CONCLUSION

It can be summarised that EN 1992-4 [1] provides a standardized and prescriptive approach suitable for routine designs whereas the SOFA method offers a more advanced research-based method for optimizing performance of anchors in critical and specialized projects. The flexibility and customization in design of anchor layouts along with integrated PROFIS Engineering provides detailed understanding of stress distributions, potential failure mechanisms and anchor performance.

- **Complex projects:** Ideal for projects involving unique or complex loading conditions, dynamic loads, e.g., seismic zones or unusual geometries.
- **Optimized design:** Suitable for projects where material optimization and economic designs are critical.
- **Customized solutions:** Used in scenarios where standard prescriptive methods do not provide adequate solutions requiring a more tailored approach.

## 9. REFERENCES

- [1] EN 1992-4:2018: Eurocode 2 - Design of concrete structures - Part 4: Design of fastenings for use in concrete, Brussels: CEN, 2018.
- [2] fib bulletin 58: Design of anchorages in concrete, Lausanne: IFSC, 2011.
- [3] P. R. Grosser, Load-bearing behavior and design of anchorages subjected to shear and torsion loading in uncracked concrete, Germany: Institut für Werkstoffe im Bauwesen der Universität Stuttgart, 2012.
- [4] K. McBride, D. Rocha and R. Figoli, Hilti Method for Anchor design in Grouted Stand-off connections, July, 2023.
- [5] K. McBride, D. Rocha and R. Figoli, Hilti Method for Anchor design in UngROUTED Stand-off connections, July, 2023.
- [6] ETA-21/0878: HST4-R Torque-controlled expansion anchor, made of stainless steel for use in concrete: sizes M8, M10, M12, M16 and M20, Marne-la-Vallée: CSTB, 28.02.2024.
- [7] ETA-19/0601: Bonded fastener and bonded expansion fasteners for use in concrete, Berlin: DIBt, 29.01.2024.



Hilti Aktiengesellschaft  
9494 Schaan, Liechtenstein  
P +423-234 2965

[www.facebook.com/hiltigroup](https://www.facebook.com/hiltigroup)  
[www.hilti.group](https://www.hilti.group)